

系列名 BACH 3 / 嵌入式射灯

项目名称

灯具型号 BHH62105PW

灯位编号

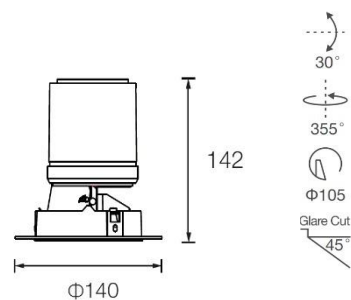

灯具规格

色温	2700K/3000K/3500K/4000K
光束角	15°/25°/35°/45°/55°
色容差	SDCM≤3
显色指数	Ra≥90
功率	18W/24W/30W
输入电压	DC36V
调光方式	非调光/0-10V/DALI
调光深度	/
灯具寿命	30000H
光源类型	LED (COB)
光源数量	1
安装方式	依据安装预埋件 (嵌入式)
天花厚度	10-20mm
产品材质	铝合金
外观颜色	哑光白
表面工艺	喷漆
重量	0.64kg
绝缘等级	Class 3
防护等级	IP20

灯具描述



BACH 3--嵌入式射灯

区分下照款与调节款，在标准款的基础上扩展了功率段，使得产品在不用更换开孔的条件下实现更高的功率，带来更高的光通量与光强以满足现场的照明需求；光学配件及下罩配件可徒手更换。

配件应用

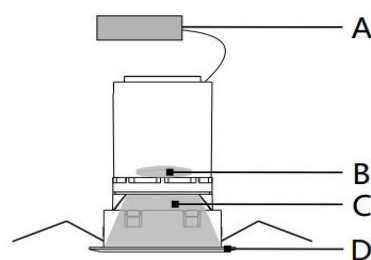

A: 恒流驱动
B: 光学配件
C: 下反光罩
D: 安装配件

可选配件

Next page...

系列名 BACH 3 / 嵌入式射灯

项目名称

灯具型号 BHH62105PW

灯位编号

可选配件



BPG13P-105/125
蜂窝网



BPG23P-105/125
拉伸镜



BP213M-105PY
圆形电镀镜面



BP213M-105BN
圆形电镀黑镍



BP213-105BK
圆形喷漆平光黑



BP213M-105CG
圆形电镀香槟金



BPY13W-105DW
圆形无边



BHEC0420-12SH
非调光恒流驱动



BHEC0600-12SH
非调光恒流驱动



BHEC0700-12SH
非调光恒流驱动

系列名 BACH 3 / 嵌入式射灯

项目名称

灯具型号 BHH62105PW

灯位编号

配光曲线

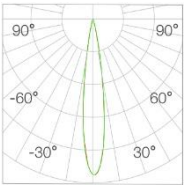
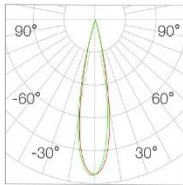
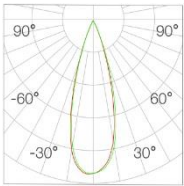
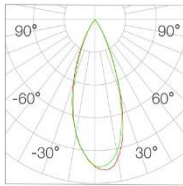
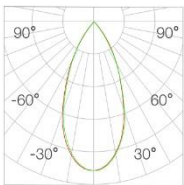
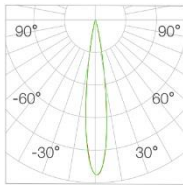
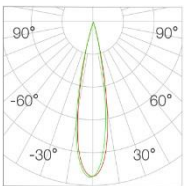
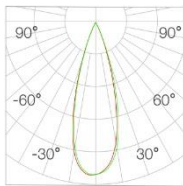
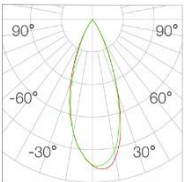
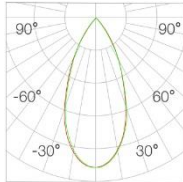
	光束角 功率 中心光强 光通量 眩光指数	15° 18W 8324cd 1126lm UGR<15	H(m) 1 2 3 4	E(lx) 8324 2081 924 520	D(cm) 29 59 89 119		光束角 功率 中心光强 光通量 眩光指数	25° 18W 5051cd 1200lm UGR<15	H(m) 1 2 3 4	E(lx) 5051 1263 561 315	D(cm) 42 85 127 170
	光束角 功率 中心光强 光通量 眩光指数	35° 18W 4532cd 1257lm UGR<15	H(m) 1 2 3 4	E(lx) 4529 1132 503 283	D(cm) 50 101 151 202		光束角 功率 中心光强 光通量 眩光指数	45° 18W 2966cd 1298lm UGR<15	H(m) 1 2 3 4	E(lx) 2966 741 329 185	D(cm) 71 142 214 285
	光束角 功率 中心光强 光通量 眩光指数	55° 18W 1874cd 1249lm UGR<15	H(m) 1 2 3 4	E(lx) 1874 468 208 117	D(cm) 93 186 279 372		光束角 功率 中心光强 光通量 眩光指数	15° 24W 11086cd 1503lm UGR<15	H(m) 1 2 3 4	E(lx) 11086 2772 1232 692	D(cm) 30 60 90 120
	光束角 功率 中心光强 光通量 眩光指数	25° 24W 6877cd 1640lm UGR<15	H(m) 1 2 3 4	E(lx) 6864 1716 762 429	D(cm) 42 84 127 169		光束角 功率 中心光强 光通量 眩光指数	35° 24W 6222cd 1724lm UGR<15	H(m) 1 2 3 4	E(lx) 6218 1555 690 388	D(cm) 50 101 151 202
	光束角 功率 中心光强 光通量 眩光指数	45° 24W 4031cd 1767lm UGR<15	H(m) 1 2 3 4	E(lx) 4031 1008 447 251	D(cm) 71 143 214 286		光束角 功率 中心光强 光通量 眩光指数	55° 24W 2547cd 1700lm UGR<15	H(m) 1 2 3 4	E(lx) 2547 636 283 159	D(cm) 93 186 279 372